

# Machinery Health™ Sensor

EZ 10xx, Eddy Current Sensors



**Copyright**

© 2021 by Emerson. All rights reserved.

No part of this publication may be reproduced, transmitted, transcribed, stored in a retrieval system, or translated into any language in any form by any means without the written permission of Emerson.

**Disclaimer**

This manual is provided for informational purposes. EMERSON MAKES NO WARRANTY OF ANY KIND WITH REGARD TO THIS MATERIAL, INCLUDING, BUT NOT LIMITED TO, THE IMPLIED WARRANTIES OF MERCHANTABILITY AND FITNESS FOR A PARTICULAR PURPOSE. Emerson shall not be liable for errors, omissions, or inconsistencies that may be contained herein or for incidental or consequential damages in connection with the furnishing, performance, or use of this material. Information in this document is subject to change without notice and does not represent a commitment on the part of Emerson. The information in this manual is not all-inclusive and cannot cover all unique situations.

**Patents**

The product(s) described in this manual are covered under existing and pending patents.

# Contents

<b>Chapter 1</b>	<b>General.....</b>	<b>5</b>
	1.1 Using this manual.....	5
	1.2 Symbols.....	5
	1.3 Liability and guarantee.....	6
	1.4 Incoming goods inspection.....	6
	1.5 Technical support.....	6
	1.6 Storage and transport.....	7
	1.7 Disposal of the device.....	7
	1.8 China RoHS Compliance.....	7
	1.9 CCC Certification – Eddy current measuring chains.....	8
	1.10 Installation awareness.....	8
<b>Chapter 2</b>	<b>Safety instructions.....</b>	<b>9</b>
	2.1 Using the device.....	9
	2.2 Owner's responsibility.....	9
<b>Chapter 3</b>	<b>Application and Design.....</b>	<b>11</b>
	3.1 The Sensors.....	11
	3.2 The Measuring Chain.....	12
<b>Chapter 4</b>	<b>Installation and Mounting.....</b>	<b>13</b>
	4.1 Choosing the measuring place.....	13
	4.2 Mount the sensor.....	14
	4.2.1 Requirements and hints for the sensor mounting.....	14
	4.3 Wiring hints.....	18
	4.4 Sensor with extension cable.....	19
<b>Chapter 5</b>	<b>Technical data.....</b>	<b>21</b>
	5.1 Measuring targets.....	21
	5.2 Measuring ranges and sensitivity.....	21
	5.3 Environmental conditions.....	22
<b>Chapter 6</b>	<b>Drawings.....</b>	<b>23</b>
<b>Chapter 7</b>	<b>Order information.....</b>	<b>31</b>
<b>Chapter 8</b>	<b>Certificates.....</b>	<b>33</b>



# 1 General

## 1.1 Using this manual

This manual contains information concerning the proper and correct use of the device.

Read the installation guide completely prior to starting installation and operating the device. Comply with all safety instructions.

Include the installation guide when transferring the device to third parties.

---

### Note

When requesting technical support, please indicate type and serial number from the type plate and the used converter type.

---

Table 1 shows a list of documents that are referred to in this installation guide.

**Table 1-1: Referenced documents**

MHM-97884	Operating manual EZ 1000, Converter for Eddy Current Sensors
MHM-97879	Operating manual Machine Studio - General Functions
MHM-97873	Operating manual A6500-UM Universal Measurement Card
MHM-97442	Operating manual AMS 6300 SIS, Overspeed Protection System

## 1.2 Symbols

---

### Note

This symbol marks passages that contain important information.

---

### CAUTION

This symbol marks operations that can lead to malfunctions or faulty measurements, but will not damage the device.



---

### DANGER

A danger indicates actions that can lead to property damage or personal injury.

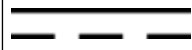
---

	According to IEC 61010, this symbol means that this device must be operated with DC voltage.
---	--

	Warning, electric shock hazard.
	According to IEC 61010, this symbol means that the documentation of the device must completely be read and understood before installing and commissioning of the device. Observe all safety related instructions in this document.

## 1.3 Liability and guarantee

Emerson is not liable for damages that occur due to improper use. Proper use also includes the knowledge of, and compliance with, this document.

Customer changes to the device that have not been approved expressly by Emerson will result in the loss of guarantee.

Due to continuous research and further development, Emerson reserves the right to change technical specifications without notice.

## 1.4 Incoming goods inspection

Check the content of the shipment to ensure that it is complete; visibly inspect the goods to determine if the device has been damaged during transport. The following parts are included in the scope of delivery and must be contained in the shipment.

- Eddy current sensor EZ 105x or EZ 108x (with protection cap)
- Extension cable EZ 190x (must be ordered separately)
- Mounting nuts
- Two shrink sleeves (a black one and a blue one) to isolate the connection between sensor cable and extension cable
- Sensor Documentation CD with Installation Guide.

If the contents are incomplete, or if you observe any defects, file a complaint with the carrier immediately. Inform the responsible Emerson sales organization so your device can be replaced. In this case, attach a tag with customer name and the observed defect.

## 1.5 Technical support

You may need to ship this product for return, replacement, or repair to an Emerson Product Service Center. Before shipping this product, contact Emerson Product Support to obtain a Return Materials Authorization (RMA) number and receive additional instructions.

### Product Support

Emerson provides a variety of ways to reach your Product Support team to get the answers you need when you need them:

<b>Phone</b>	Toll free 800.833.8314 (U.S. and Canada) +1.512.832.3774 (Latin America) +63.2702.1111 (Asia Pacific, Europe, and Middle East)
<b>Email</b>	<a href="mailto:ap-sms@emerson.com">ap-sms@emerson.com</a>
<b>Web</b>	<a href="http://www.emerson.com/en-us/contact-us">http://www.emerson.com/en-us/contact-us</a>

To search for documentation, visit <http://www.emerson.com>.

To view toll free numbers for specific countries, visit <http://www.emersonprocess.com/technicalsupport>.

---

**Note**

If the equipment has been exposed to a hazardous substance, a Material Safety Data Sheet (MSDS) must be included with the returned materials. An MSDS is required by law to be available to people exposed to specific hazardous substances.

---

## 1.6 Storage and transport

Store and transport the device only in its original packaging. Technical data specifies the environmental conditions for storage and support.

**Related information**

[Technical data](#)

## 1.7 Disposal of the device

Provided that no repurchase or disposal agreement exists, recycle the following components at appropriate facilities:

- Recyclable metal
- Plastic elements

Sort the remaining components for disposal, based on their condition. National laws or provisions on waste disposal and protection of the environment apply.

---

**Note**

Environmental hazards! Electrical waste and electronic components are subject to treatment as special waste and may only be disposed by approved specialized companies.

---

## 1.8 China RoHS Compliance

Our products manufactured later than June 30, 2016 and those which are sold in the People's Republic of China are marked with one of the following two logos to indicate the Environmental Friendly Use Period in which it can be used safely under normal operating conditions.

Products without below mentioned marking are either manufactured before June 30 or are non-electrical equipment products (EEP).



Circling arrow symbol with "e": The product contains no hazardous substances over the Maximum Concentration Value and it has an indefinite Environmental Friendly Use Period.



Circling arrow symbol with a number: This product contains certain hazardous substances over the Maximum Concentration Value and it can be used safely under normal operating conditions for the number of years indicated in the symbol. The names and contents of hazardous substances can be found in the folder "China RoHS Compliance Certificates" on the documentation CD or DVD enclosed with the product.

## 1.9 CCC Certification – Eddy current measuring chains

With the announcement of the Chinese market regulation authority SAMR (State Administration for Market Regulation), a Compulsory Product Certification (CCC certification) is mandatory for many explosion protection products. This explosion proof ("Ex") product complies to the CCC obligation and is certified (certification number: 2020322315002448).



This China Compulsory Certificate mark (CCC), is a compulsory safety mark for many products imported, sold, or used in the Chinese market and indicates that the product is certified in accordance to GB 3836.1-2010, GB 3836.4-2010, and GB 3836.8-2014. If the product label is too small to contain the CCC certification mark it is sufficient to have the mark printed on the minimum package and in the attached document.

## 1.10 Installation awareness

### Note

When planning a measurement, observe the following items:

- Consider environmental conditions which might have an influence on the measurement such as temperature, humidity, substances aggressive to the sensor, and pollution.
- Always use a stiff and vibration-free sensor holder.
- Define a suitable measuring range, not larger than necessary, in consultation with the operator of the plant.
- Define the trip limit in consultation with the operator of the plant.
- Take measurement deviations into account when defining the trip limit.
- Use a sensor that meets the requirements of the defined measuring range.
- Ensure an EMC-compatible installation including the use of proper cables.
- Ensure proper function of the measurement before activating the measurement for regular operation.



## 2 Safety instructions

To ensure safe operation, carefully observe all instructions in this manual.

The correct and safe use of this device requires that operating and service personnel both understand and comply with general safety guidelines and observe the special safety comments listed in this manual. Where necessary, safety-sensitive points on the device are marked.

### **⚠ DANGER**

Because the device is electrical equipment, commissioning and service must be performed only by trained and authorized personnel. Maintenance must be carried out only by trained, specialized, and experienced personnel.

---

### 2.1 Using the device

Install and use the device as specified in this manual.

If the device is used in a manner not specified by the manufacturer, the protection provided by the device may be impaired.

### 2.2 Owner's responsibility

If there is a reason to suspect that hazard-free operation, and thus, adequate machine protection is no longer possible, take the device out of operation and safeguard it from unintentional operation. This is the case:

- if the device shows visible damage.
- if the device no longer works.
- after any kind of overload that has exceeded the permissible limits (such as those detailed in chapter "Technical data," section "Environmental conditions").

### **⚠ DANGER**

If device tests have to be completed during operation or if the device has to be replaced or decommissioned, it will impair the machine protection and may cause the machine to shut down. Make sure to deactivate machine protection before starting such work, and reactivate it after work has been completed.

---

#### **Related information**

[Environmental conditions](#)



## 3 Application and Design

### 3.1 The Sensors

The 5 mm and 8 mm sensors EZ 105x and EZ 108x are available in different variants. With or without the optional EZ 190x extension cable . See [Order information](#) for details. [Figure 3-1](#) explains the parts of an EZ 105x and EZ 108x Sensor.

**Figure 3-1: Design EZ 105x and EZ 108x**

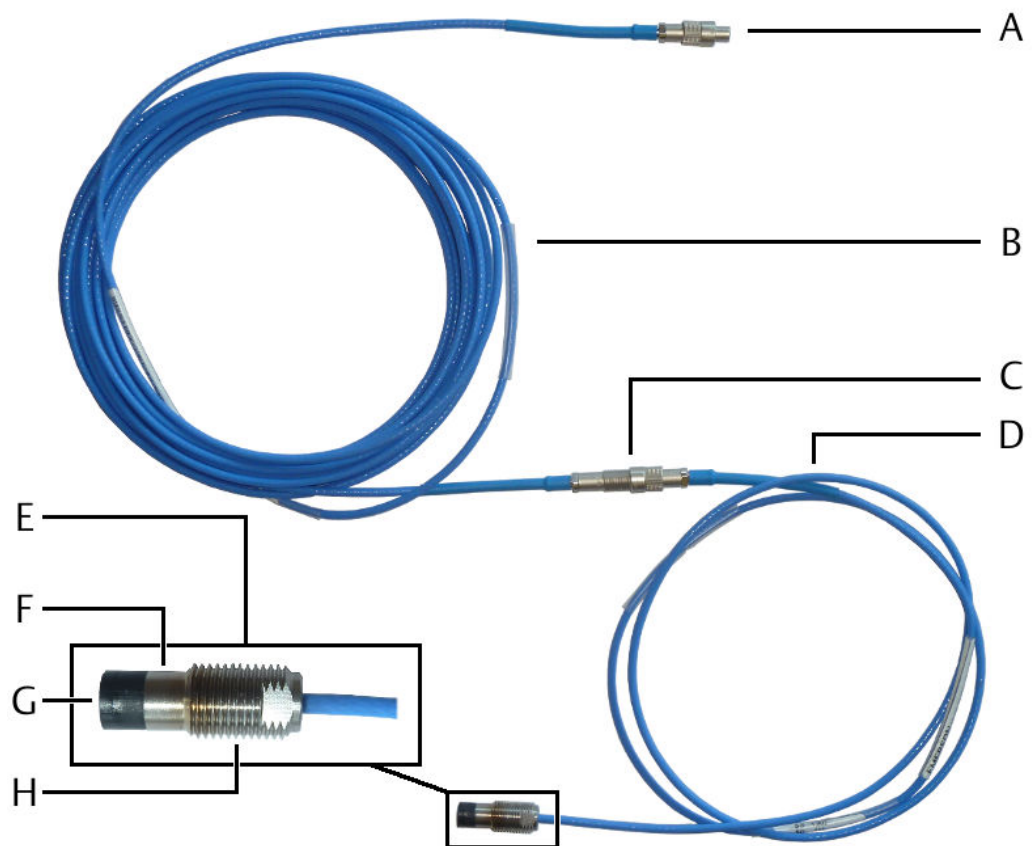

- A. Plug with cap nut of the extension cable
- B. EZ 190x extension cable (optional)
- C. Connection (plug of the sensor cable with cap nut and socket of the extension cable)
- D. Sensor cable
- E. EZ 10xx Eddy Current Sensor
- F. Unthreaded part of the sensor case
- G. Sensor tip
- H. Threaded part of the sensor case

Which sensor type is applicable for a measuring application depends on several requirements such as desired measuring range, available measuring track, and maximum environmental temperature. Each EZ 105x or EZ 108x sensor requires an EZ 1000 converter to complete the measuring chain. Use the EZ 190x extension cable to adjust the sensor cable length to the installation requirements.

---

**Note**

Ensure that the overall cable length, sensor cable plus extension cable, does not exceed 10 meters.

---

## 3.2 The Measuring Chain

An EZ 105x or EZ 108x sensor, together with the EZ 1000 converter, form the eddy current measuring chain. Use this measuring chain for contactless distance, vibration, or speed measurements. Different types of sensors and the software-configurable EZ 1000 converter allow an optimal adaption to the requirements of the machine to be monitored.

---

**Figure 3-2: Eddy current measuring chain**



- A. EZ 1000 converter
- B. EZ 190x extension cable (optional)
- C. EZ 10xx sensor

---

To achieve a high accuracy, the parts of the measuring chain, the sensor, the sensor cable (sensor cable plus optional extension cable), and the converter, are calibrated together. See EZ 1000 operating manual for the calibration details.

The characteristics of the measuring chain also depend on the material of the measuring object (target), for example, the machine shaft material. The material mainly used for turbo machinery is 42 Cr Mo 4, according to SAE 4140. During the calibration process, the measuring chain is adapted to the material.

## 4 Installation and Mounting

### 4.1 Choosing the measuring place

Figure 4-1 is an example scheme for where to place the sensors on a turbine shaft to measure the axial displacement, shaft vibration, or speed. Consider the minimum shaft diameter for the sensor type, the minimum material width in front of the sensor tip, and the minimum gap (see [Requirements and hints for the sensor mounting](#)).

To measure shaft vibration, Emerson recommends using a sensor holder between bearing and turbine housing, as close as possible to the rotor.

**Figure 4-1: Example scheme where to place the sensors**

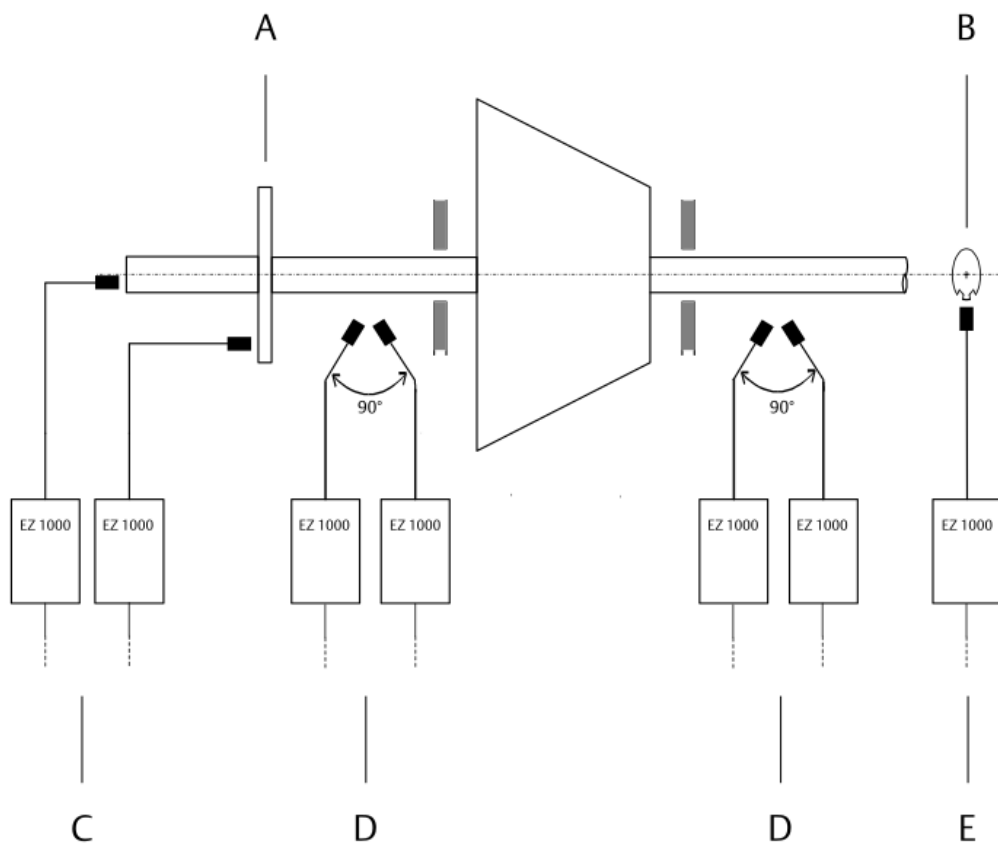

- A. Measuring collar
- B. Trigger wheel
- C. Measuring chain for measuring shaft displacement with EZ 1000 and EZ 105x or EZ 108x.
- D. Measuring chain for measuring shaft vibration with EZ 1000 and EZ 105x or EZ 108x.
- E. Measuring chain for measuring speed/key with EZ 1000 and EZ 105x or EZ 108x.

## 4.2 Mount the sensor

The following steps describe the mounting of the EZ 105x and EZ 108x sensor types. See also the respective EZ 1000 converter manual as listed in [Table 1-1](#) for further details regarding sensor adjustment.

### Prerequisites

Calibrated eddy current measuring chain.

### Procedure

1. Screw in the sensor into the holder.  
Ensure that the threads are clean and smooth-running.  
Do not bend or twist the sensor cable. If the sensor cable has an adapter plug, open it.  
To avoid touching the shaft during installation, the maximum distance between measuring target and sensor tip must be adjusted first. Screw in the sensor until the converter output voltage starts changing (approximately at -20V DC). Close the adapter plug for measuring the converter output voltage.
2. Adjust the distance between measuring target and sensor tip according to the measuring task.  
Use a voltmeter connected to the converter output to measure the output voltage. Open the adapter plug at every two turns of the sensor to untwist the cable.  
Ensure that in the direction of the sensor tip, at least the always unthreaded part of the sensor case (length EZ 105x: 5.0 mm and length EZ 108x: 5.0 mm) remains free.
3. Secure the sensor by fixing the nuts.  
The maximum tightening torque for fixing the nuts is:
  - EZ 105x: 1 Nm
  - EZ 108x: 15 Nm

### 4.2.1 Requirements and hints for the sensor mounting

This section contains information and installation requirements for the sensor. The final adjustment of the sensor depends on the measuring task and requires a complete measuring chain. The EZ 1000 converter manual and the manuals for the evaluation electronics, such as the AMS 6500 ATG system, contain detailed information regarding the final adjustment.

#### General holder requirement

To mount the sensor, use a stiff and vibration-free holder with a mounting thread for the selected sensor.

#### General distance adjustment

For distance adjustment, the complete measuring chain consisting of sensor and converter is required as the distance will be generally adjusted by means of the converter output voltage.

### Sensor fastening

- Use the enclosed nuts when installing sensors.
- Lock nuts to avoid loosening of the sensor. Loose parts can fall into the machine and cause damage. A medium-grade, removable, screw-securing adhesive (for example: Loctite® 242, blue) is recommended to secure the sensor.

### Measuring track on the measuring target

The measuring track on the measuring target must be free from irregularities as scratches, corrosion, stress concentrations, metallurgical segregation, and should have a high concentricity. These irregularities may cause changes in the converter output voltage which are not related to a real position or vibration signal. The signal caused by these irregularities is called runout. For the measuring track, Emerson recommends a surface finish of  $0.41\ \mu\text{m}$  to  $0.76\ \mu\text{m}$ .

### Free space

Ensure there is  $45^\circ$  of free space around the sensor head for all sensor types.

**Figure 4-2: Free space around sensor head**

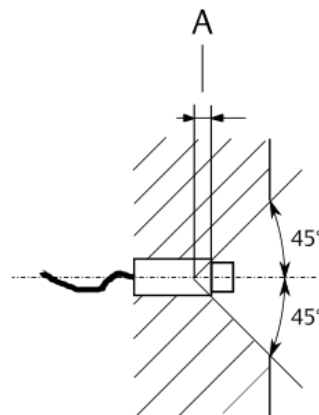

A. At least two threads visible

Free space EZ 105x and EZ 108x:  $\pm 45^\circ$

### **⚠ CAUTION**

If you do not ensure the free space specifications, the measuring range at the upper end decreases and the linearity error increases.

### Maximum axial tilting angle

Ensure that the maximum axial tilting angle  $\alpha$  is  $< 2^\circ$ . There is no significant influence on the measuring result in this case.

**Figure 4-3: Maximum axial tilting**

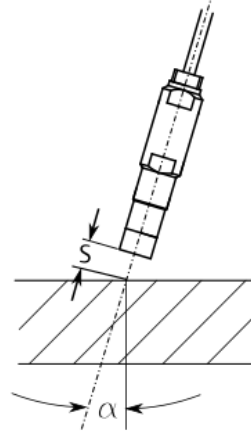

**S:** distance between measuring target and sensor tip

**a:** maximal axial tilting angle  $< 2^\circ$

**Maximum tangential offset**

Ensure the maximum tangential offset matches the values in [Table 4-1](#). [Figure 4-4](#) shows the definition of the tangential offset.

**Table 4-1: Maximum tangential offset**

Sensor type	Max. offset X	Shaft diameter D
EZ 105x	0.2 mm	$\geq 20$ mm
EZ 108x	0.5 mm	$\geq 40$ mm

**Figure 4-4: Maximum tangential offset**

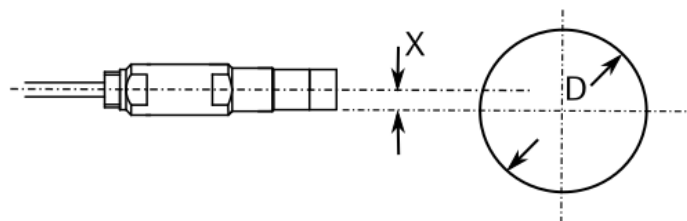

**X:** maximal tangential offset

**D:** shaft diameter

**Minimum measuring area**

Ensure that the minimum measuring area matches the values in [Table 4-2](#). [Figure 4-5](#) shows the definition of the minimum measuring area.



**Table 4-2: Minimum measuring area**

Sensor type		Target diameter	Additional linearity error
EZ 105x	Recommended	>20 mm	<1%
	Minimum	10 mm	
EZ 108x	Recommended	>20 mm	<1%
	Minimum	14 mm	

**Figure 4-5: Minimum measuring area**

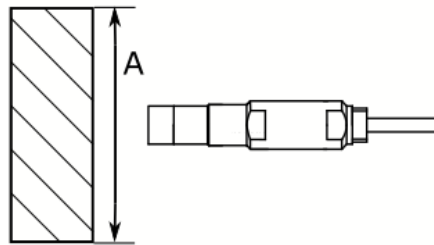

If using the EZ 10xx sensors for speed measurement or key generation see referenced protection card manuals for trigger wheel specifications.

**Minimum lateral distance**

Ensure that there is a sufficient lateral distance to ferromagnetic material. The minimum lateral distance depends on the measuring range extension. See [Table 4-3](#).

**Figure 4-6: Minimum lateral distance**

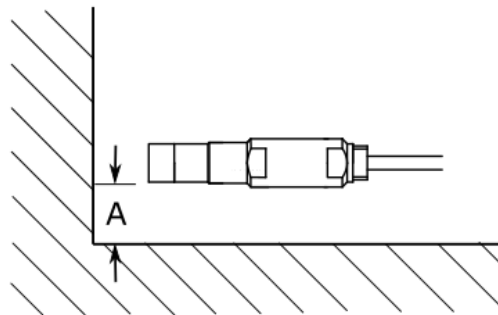

*A. Lateral distance between sensor sleeve and ferromagnetic material*

**Table 4-3: Minimum lateral distance**

Sensor type	Extended range factor <sup>1</sup>	Minimum distance	Additional linearity error
EZ 108x	1.0	>5 mm	<1%
	1.5	>7 mm	<1%

**Table 4-3: Minimum lateral distance (continued)**

Sensor type	Extended range factor <sup>1</sup>	Minimum distance	Additional linearity error
	2.0	>10 mm	<1%
EZ 105x	1.0	>5 mm	<1%
	1.5	>5 mm	<5%
	2.0	>5 mm	<5%

<sup>1</sup> See Operating manual EZ 1000 (MHM-97884).

## 4.3 Wiring hints

This section contains general information and wiring hints regarding the sensor cable installation. As always, proper cable installation depends on observations and judgments based on the situation on-site. Observe the following points for a reliable cable installation:

- Do not bend or twist the sensor cables. Cables and connectors must be movable when the sensor is screwed into the holder.
- Install the cable strain-free and spin-free such that it is protected against mechanical damages.
- Do not shorten the sensor cable or the extension cable. Roll up the excess cable (rolling diameter  $\geq 100$  mm).
- Ensure that no parts of the cable, including the adapter plug, touch any rotating parts of the machine.
- Note that machines can expand or shrink due to temperature influences. Always install the sensor cable with a cable length reserve to compensate the thermal behavior of the machine.
- Only install cables with a minimum bending radius of 25 mm. For sensor cables with metal protection tubes, the minimum bending radius is 35 mm.
- Avoid oil stream areas for sensor cableways. Be sure that no oil stream or other agitations will permanently move the cable.
- Avoid sensor cableways where the cable is permanently submerged in oil.
- Affix the sensor cable at recurring short distances.
- Do not squeeze the cable, for example, between metal plates for fixing. Squeezing the cable will damage the outer isolation, which could allow oil into the cable or causes short-circuits.
- Lead the sensor cable through the bearing pedestal wall (machine case), below the horizontal joint of the machine and above the residual oil level in the bearing pedestal. Do not lead the sensor cable through the upper or removable pedestal cover. This could cause problems during machine maintenance, and represents a safety concern.
- Always keep a distance between adjacent sensor cables to avoid mutual influence. Do not bundle sensor cables over a long distance.

- Place junction boxes on a higher level than the sensor to stop oil from entering the cable protection tubes. You can also use swan-necks for the same purpose.

## 4.4 Sensor with extension cable

Observe the following hints if using an EZ 190x extension cable to extend the sensor cable.

### Connection

- To connect, screw the plug of the sensor cable finger tight into the corresponding plug socket of the extension cable.
- To unlock, unscrew the plug.

### Connector isolation

Cover the connection (plug and socket) with the shrink sleeve included into the delivery. The shrinking temperature of the shrink sleeve with an approximately length of 100 mm is approximately 200°C. Applying a shrink sleeve to the connector isolates and protects the connection and is always required – even when using metal protection tubes.

**Figure 4-7: Overview shrink sleeve**

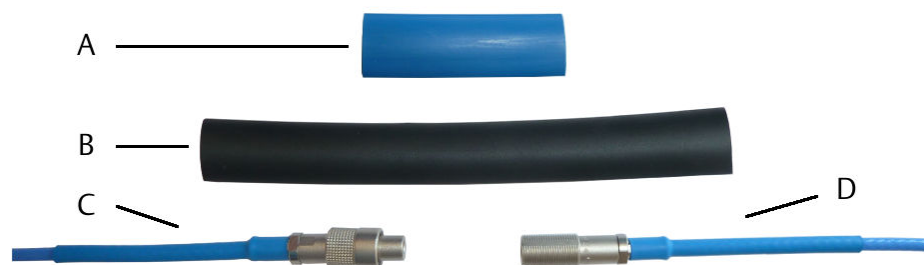

- A. Blue shrink sleeve – only necessary for installations at hazardous locations.
- B. Black shrink sleeve
- C. Plug of the sensor cable
- D. Socket of the extension cable

### Apply shrink sleeve to a connector

1. At the open connection, push the black shrink sleeve over one connector so that the sleeve completely covers the sensor cable.
2. Close the connection.

**Figure 4-8: Closed connection**



3. Move the shrink sleeve over the closed connection. Plug and socket should be completely covered by the shrink sleeve. The black shrink sleeve should evenly overlap plug and socket.

---

**Figure 4-9: Shrink sleeve in position**



4. Use a hot air gun to evenly shrink the sleeve. The required shrinking temperature is approximately 200°C.
5. Ensure that the shrunken sleeve touches sensor cable, plug, and socket. It is important that the shrink sleeve cannot slip from the connection.

---

**Note**

If installing the sensor at hazardous locations, additionally shrink the blue shrink sleeve (contained in the delivery) over the first black one.

---

## 5 Technical data

Only specifications with tolerances are guaranteed. Data without tolerance or without error limits are informative data and not guaranteed. Technology is under constant development, and specifications are subject to change without notice.

All specifications are valid for a measuring chain consisting of a sensor EZ 105x or EZ 108x and an EZ 1000 converter adjusted to the sensor.

### 5.1 Measuring targets

		EZ 105x	EZ 108x
Measuring target		shafts and plain surfaces	
Shaft diameter	Minimum	15 mm	20 mm
	Recommended	>20 mm	>25 mm
Height of target (measuring collar) on the shaft		>20 mm	>25 mm
Speed of shaft circumference		0 ... 2500 m/s	
Object material		electrical conducting materials	
Reference material		1.7224 (42 Cr Mo 4; AISI/SAE 4140)	
Target material		P235S C35 (AISI/SAE 1035) 34CrMo4 (AISI/SAE 4337, 4340) 26NiCrMoV14 ST 37, S235JR X35CrMo17 Other (On Request)	

### 5.2 Measuring ranges and sensitivity

Sensor	EZ 105x	EZ 108x
Nominal measuring range, static measurements	±0.5 mm	±1.0 mm
Nominal measuring range, dynamic, peak – peak (recommended)	25 ... 250 µm	50 ... 500 µm
Sensitivity for 42 Cr Mo 4	16 V/mm	8 V/mm
Value for nominal distance at the center point of converter output signal	0.75 mm	1.5 mm
Initial air gap	0.25 mm	0.5

## 5.3 Environmental conditions

Environmental temperature	
Reference value	+23°C
Nominal operating range	-35°C to +180°C (sensor inclusive 1 m cable)
Nominal range for cable and connector	-35°C to +150°C
Limits for storage and transport	-40°C to +70°C
Temperature error (according to API 670, only sensor)	4 % per 100 K
Humidity	5 to 95%, non condensing Additional linearity error of ±0.2% for EZ 105x and EZ 108x with 5 meter sensor cable and standard measuring range at 10 to 100 % relative humidity (rh), condensing.
Resistance to chemicals (at room temperature)	Sensor and cable are resistant to: water, steam, natural gas, helium, bearing oils, gasoline, benzol, nitric acid, tetra carbon chloride, tetra chloride ethylene.
Pressure	
Pressure resistance to sensor tip	10000 hPa Sensors are sealed against oil leakage.
Pressure and differential pressure resistance at cable outlet	Pressure test certificate on request
maximal Vibration	5g at 60 Hz
Dimensions	see <a href="#">Drawings</a>
Material	Sensor tip: PEEK Polyether Ether Ketone Case: Stainless Steel Cable: FEP Flourinated Ethylene Propylene Connector: Brass, nickel-plated
Metal protection tube (EZ 1051, EZ 1053, EZ 1081, and EZ 1083)	stainless steel
Weight (sensor with 1 m cable)	Approximately 100 g

## 6 Drawings

Figure 6-1: EZ 1050-xx-xx-xxx

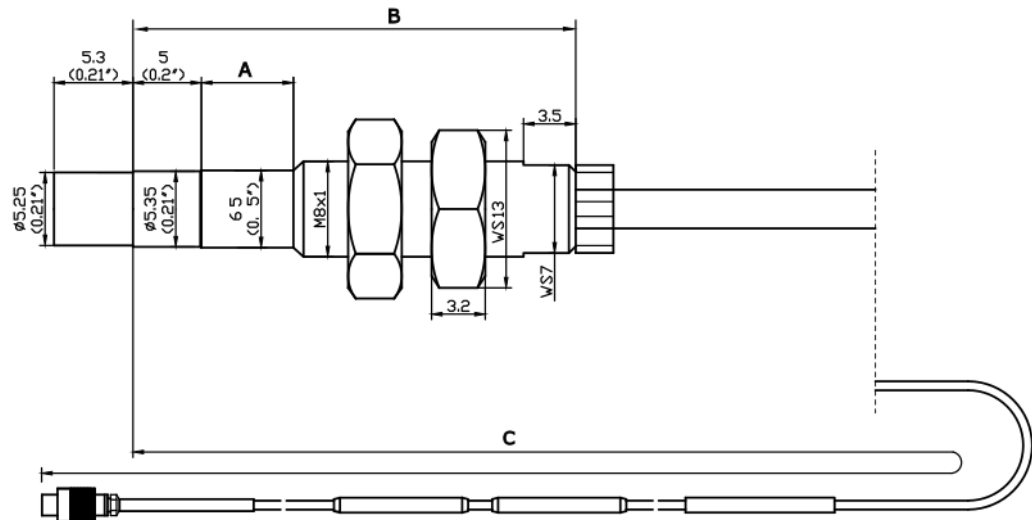

- A. Unthreaded length (see [Order information](#) for available lengths)
- B. Case length (see [Order information](#) for available lengths)
- C. Overall cable length (see [Order information](#) for available lengths, tolerance 0 ... +10%)

The dimensions without parentheses are in mm and the dimensions in parentheses are in inch.

Figure 6-2: EZ1051-xx-xx-xxx

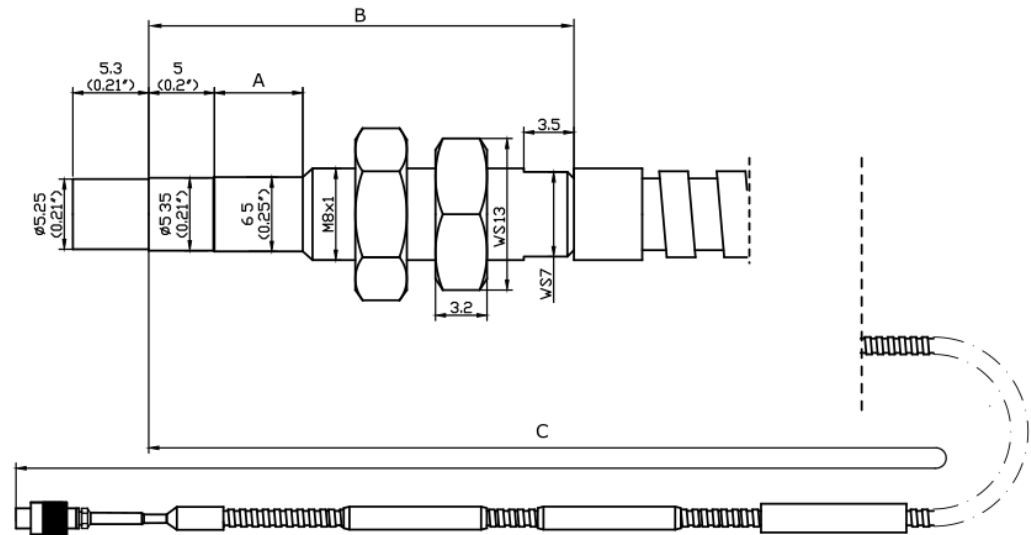

- A. Unthreaded length (see [Order information](#) for available lengths)
- B. Case length (see [Order information](#) for available lengths)
- C. Overall cable length (see [Order information](#) for available lengths, tolerance 0 ... +10%)

The dimensions without parentheses are in mm and the dimensions in parentheses are in inch.



Figure 6-3: EZ 1052-xx-xx-xxx

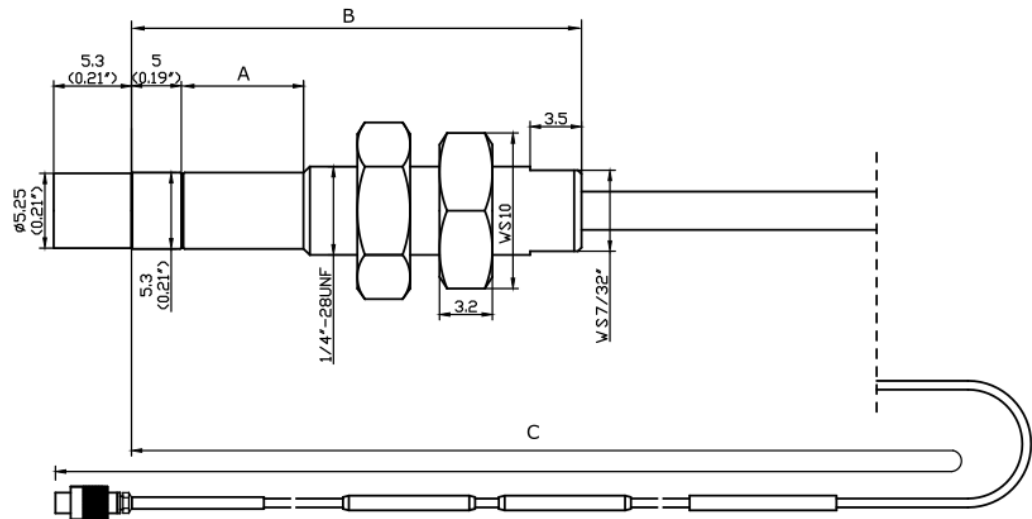

- A. Unthreaded length (see [Order information](#) for available lengths)
- B. Case length (see [Order information](#) for available lengths)
- C. Overall cable length (see [Order information](#) for available lengths, tolerance 0 ... +10%)

The dimensions without parentheses are in mm and the dimensions in parentheses are in inch.

Figure 6-4: EZ 1053-xx-xx-xxx

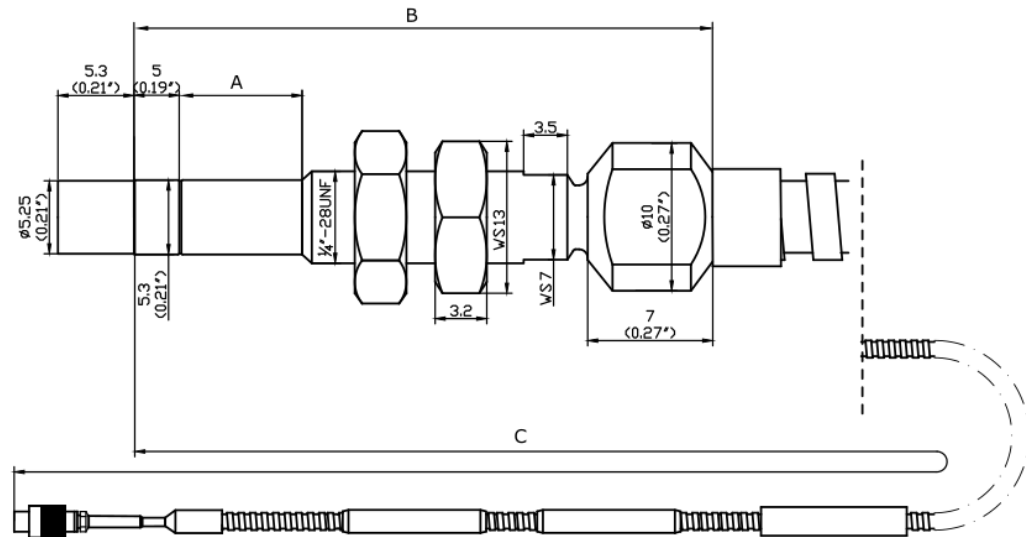

- A. Unthreaded length (see [Order information](#) for available lengths)
- B. Case length (see [Order information](#) for available lengths)
- C. Overall cable length (see [Order information](#) for available lengths, tolerance 0 ... +10%)

The dimensions without parentheses are in mm and the dimensions in parentheses are in inch.

Figure 6-5: EZ 1080-xx-xx-xxx

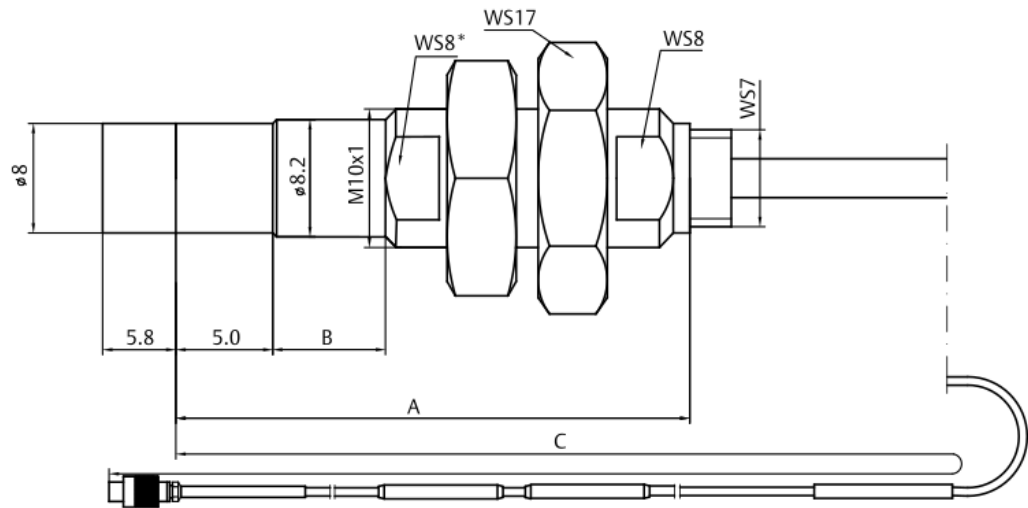

\* WS8 spanner flat not available with 20 mm (0.8 in) and unthreaded length case

A. Case length (see [Order information](#) for available lengths)

B. Unthreaded length (see [Order information](#) for available lengths)

C. Overall cable length (see [Order information](#) for available lengths, tolerance 0 ... +10%)

All dimension in mm.

Figure 6-6: EZ 1081-xx-xx-xxx

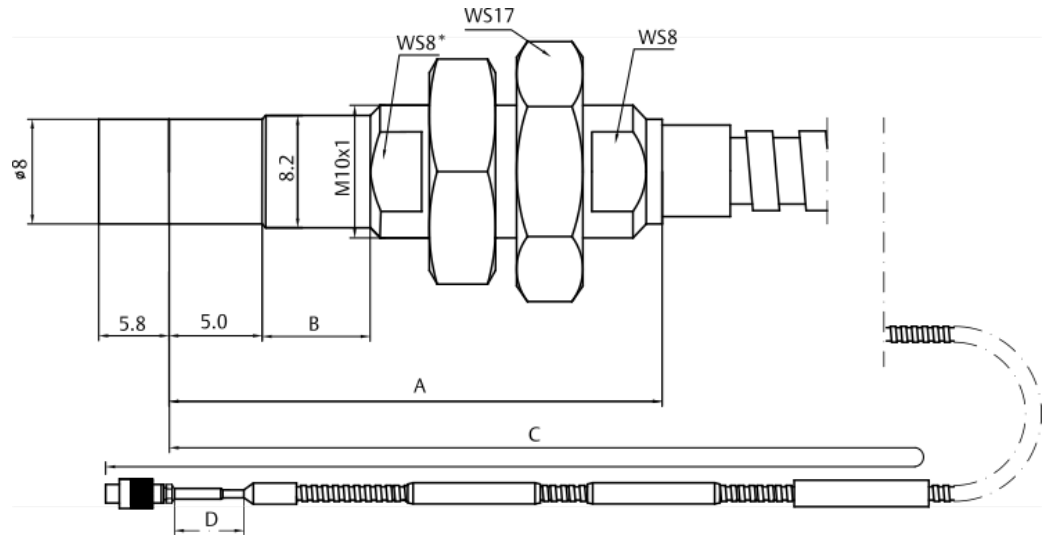

\* WS8 spanner flat not available with 20 mm (0.8 in) and unthreaded length case

- A. Case length (see [Order information](#) for available lengths)
- B. Unthreaded length (see [Order information](#) for available lengths)
- C. Overall cable length (see [Order information](#) for available lengths, tolerance 0 ... +10%)

D.

<b>Cable length</b>	<b>D</b>
1 m	<30 mm
5 m	>300 mm
10 m	>300 mm

All dimension in mm.

**Figure 6-7: EZ 1082-xx-xx-xxx**

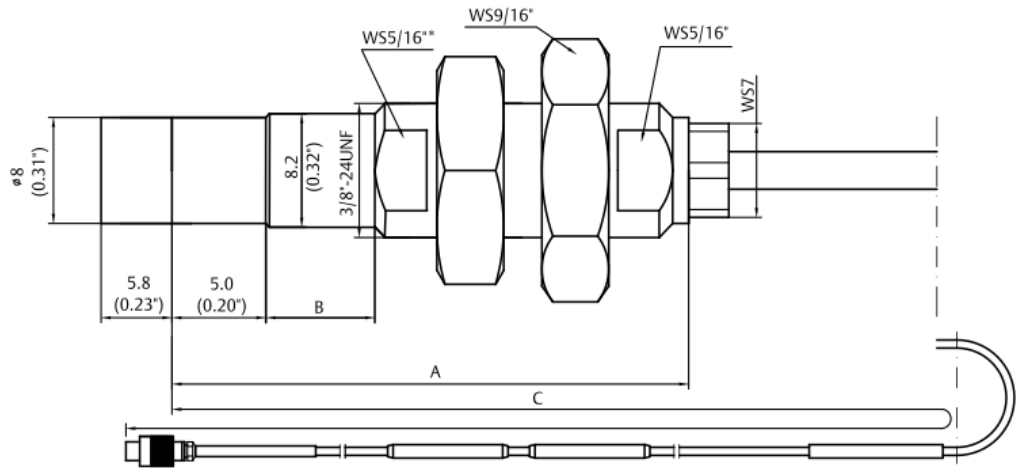

\* WS5/16" spanner flat not available with 20 mm (0.8 in) and unthreaded length case

- A. Case length (see [Order information](#) for available lengths)
- B. Unthreaded length (see [Order information](#) for available lengths)
- C. Overall cable length (see [Order information](#) for available lengths, tolerance 0 ... +10%)

The dimensions without parentheses are in mm and the dimensions in parentheses are in inch.

**Figure 6-8: EZ 1083-xx-xx-xxx**

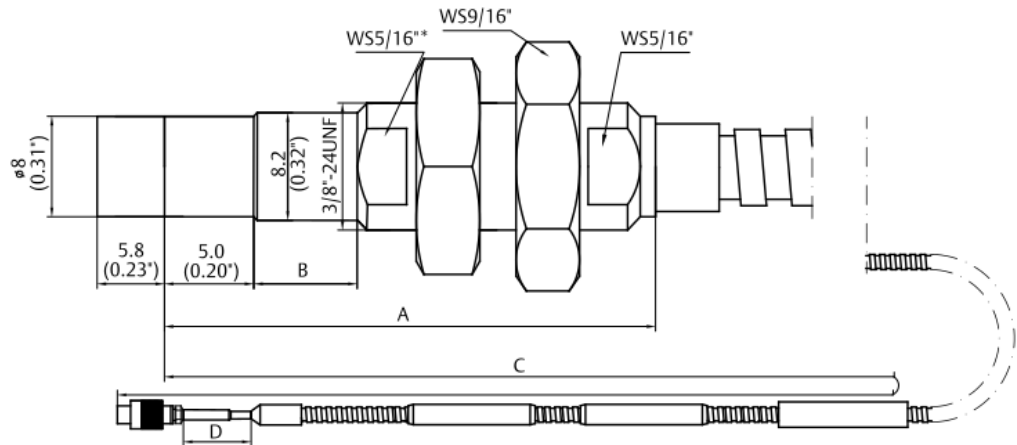

\* WS5/16" spanner flat not available with 20 mm (0.8 in) and unthreaded length case

- A. Case length (see [Order information](#) for available lengths)
- B. Unthreaded length (see [Order information](#) for available lengths)
- C. Overall cable length (see [Order information](#) for available lengths, tolerance 0 ... +10%)

D. Cable length	D
1 m	<30 mm

<b><i>Cable length</i></b>	<b><i>D</i></b>
5 m	>300 mm
10 m	>300 mm

The dimensions without parentheses are in mm and the dimensions in parentheses are in inch.

---

## 7 Order information

The EZ 105x and EZ 108x sensors can be ordered in different variations according to [Table 7-1](#) and [Table 7-2](#). Use the EZ 190x extension cable to adjust the cable length to your needs (see [Table 7-3](#)).

### Note

Ensure that the overall cable length, sensor cable plus extension cable, does not exceed 10 meters.

**Table 7-1: Ordering information - Sensor**

Tip diameter	Case thread	Armored cable	Model No.
5 mm	M8x1	No	EZ1050
		Yes	EZ1051
8 mm	M10x1	No	EZ1080
		Yes	EZ1081
5 mm	1/4"-28 UNF	No	EZ1052
		Yes	EZ1053
8 mm	3/8"-24 UNF	No	EZ1082
		Yes	EZ1083

**Table 7-2: Ordering matrix - sensor**

Model No.	-	Case length XX	-	Unthreaded length XX	-	Cable length XXX <sup>12</sup>
EZ1050	-	<b>02</b> <sup>3</sup> 20 mm (Minimum) to <b>25</b> 250 mm (Maximum <sup>4</sup> ) Order in increments of 10 mm. <b>RM</b> Reverse Mount <sup>5</sup>	-	<b>00</b> 0 mm (no unthreaded length) <b>05</b> 50 mm (Minimum) to <b>20</b> 200 mm (Maximum <sup>6</sup> )	-	<b>005</b> 0.5 m <b>010</b> 1.0 m <b>015</b> 1.5 m <b>020</b> 2.0 m <b>050</b> 5.0 m <b>100</b> 10.0 m <b>150</b> <sup>7</sup> 15.0 m <b>300</b> <sup>7</sup> 30.0 m
EZ1051						
EZ1080						
EZ1081						
EZ1052	-	<b>08</b> <sup>8</sup> 0.8 in <b>10</b> 1.0 in (Minimum) to <b>95</b> 9.5 in (Maximum <sup>9</sup> ) Order in increments of 0.5 in.	-	<b>00</b> 0 in (no unthreaded length) <b>20</b> 2.0 in (Minimum) to <b>75</b> 7.5 in (Maximum <sup>10</sup> )	-	
EZ1053						
EZ1082						

**Table 7-2: Ordering matrix - sensor (continued)**

Model No.	-	Case length XX	-	Unthreaded length XX	-	Cable length XXX <sup>12</sup>
EZ1083		RM Reverse Mount <sup>5</sup>				

- 1 The usage of EZ190x Extension Cable is possible with options 0.5 m, 1.0 m, 1.5 m, and 2.0 m.
- 2 When using sensors in combination with extension cables, the overall system length must be 4.0 m, 5.0 m, 6.0 m, 7.0 m, 8.0 m, 9.0 m, or 10.0 m.
- 3 The 20 mm case is only available with EZ 1050 and EZ 1080.
- 4 The maximum case length of EZ 105x sensors is 100 mm.
- 5 Reverse Mount is only available with EZ 108x sensors.
- 6 The remaining threaded length must be either 50 mm or 100 mm.
- 7 On request (non-standard), 30.0 m not available with EZ 105x sensors.
- 8 The 0.8 in case is only available with EZ 1052 and EZ 1082.
- 9 The maximum case length of EZ 105x sensors is 4.0 in.
- 10 The remaining threaded length must be either 2.0 in or 4.0 in.

Example:

EZ1080-02-00-050

EZ 8 mm, M10x1, No armor, 20 mm sleeve, 0 mm unthreaded, 5 m cable

**Table 7-3: Ordering matrix - extension cable**

Sensor cable	Armored cable X	-	Cable length XXX
EZ190	0 No		<b>020</b> 2.0 m
EZ190	1 Yes		<b>025</b> 2.5 m
			<b>030</b> 3.0 m
			<b>035</b> 3.5 m
			<b>040</b> 4.0 m
			<b>045</b> 4.5 m
			<b>050</b> 5.0 m
			<b>055</b> 5.5 m
			<b>060</b> 6.0 m
		-	<b>065</b> 6.5 m
			<b>070</b> 7.0 m
			<b>075</b> 7.5 m
			<b>080</b> 8.0 m
			<b>085</b> 8.5 m
			<b>090</b> 9.0 m
			<b>095</b> 9.5 m
			<b>140</b> 14.0 m <sup>1</sup>
			<b>290</b> 29.0 m <sup>1</sup>

- 1 On request (non-standard), 30.0 m not available with EZ 105x sensors.

Example:

EZ1900-040

EZ190 extension cable, no armor, 4 m cable



# 8 Certificates



## EU-Declaration of Conformity (Translation)

We: epro GmbH, Jöbkesweg 3, 48599 Gronau

declare under our sole responsibility that following product(s):

Product designation:	EZ 1000
Product description:	Eddy current measurement system consisting of signal converter type EZ 1000 with sensors types EZ 105x, EZ 108x, PR 6422, PR 6423, PR 6424, PR 6425 and PR 6426
Part numbers	EZ1000 EZ105x-xx-xx-xxx EZ108x-xx-xx-xxx PR642x/xxx-xxx

are in conformity with the terms of the directives mentioned below including any amendment valid at the date of declaration:

2014/30/EU	Electromagnetic compatibility
2014/34/EU	Equipment and protective system intended for use in potentially explosive atmospheres
2011/65/EU	The restriction of the use of certain hazardous substances in electrical and electronic equipment

Following harmonized standards have been applied:

2014/30/EU	EN 61326-1	Electrical equipment for measurement, control and laboratory use. EMC requirements Part 1. General requirements
2014/34/EU	EN 60079-0	Explosive atmospheres - Part 0: Equipment - General requirements
	EN 60079-11	Explosive atmospheres - Part 11: Equipment protection by type of protection "I"
	EN 60079-15	Explosive atmospheres - Part 15: Equipment protection by type of protection "n"
2011/65/EU	DIN EN 50581	Technical documentation for the assessment of electrical and electronic products with respect to the restriction of hazardous substances

For the type examination according to EN 60079-0, EN 60079-11 and EN 60079-15 the following notified body has been involved;

DEKRA EXAM GmbH  
Type examination certificate BVS 18 ATEX E 011 X

Authorized person for technical documentation:

Bruno Hecker, Jöbkesweg 3, 48599 Gronau

Gronau, 15<sup>th</sup> July, 2018  
Place, Date

  
Site Leader  
Quality

**Emerson**

12001 Technology Drive  
Eden Prairie, MN 55344 USA  
T 1(952)828-3000  
[www.Emerson.com](http://www.Emerson.com)

**Emerson**

835 Innovation Drive  
Knoxville, TN 37932 USA  
T +1 865-675-2400  
F +1 865-218-1401  
[www.Emerson.com](http://www.Emerson.com)

**Emerson**

Jöbkesweg 3  
48599 Gronau  
Germany  
T +49 2562 709 0  
F +49 2562 709 401  
[www.Emerson.com/ams](http://www.Emerson.com/ams)

©2021, Emerson.

The contents of this publication are presented for informational purposes only, and while every effort has been made to ensure their accuracy, they are not to be construed as warranties or guarantees, express or implied, regarding the products or services described herein or their use or applicability. All sales are governed by our terms and conditions, which are available on request. We reserve the right to modify or improve the designs or specifications of our products at any time without notice.

All rights reserved. AMS is a mark of one of the Emerson group of companies. The Emerson logo is a trademark and service mark of Emerson Electric Co. All other marks are the property of their respective owners.

